

# INSTALLATION MANUAL

MONTERINGSANVISNING  
MONTERINGSANVISNING  
MONTERINGSVEJLEDNING  
ASENNUSOHJE

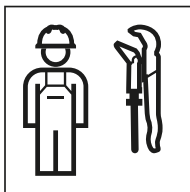

970-224-00-0(00)

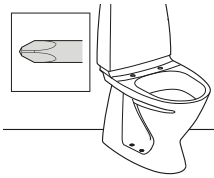

➔ **A** 2



➔ **B** 4

**A**

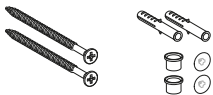
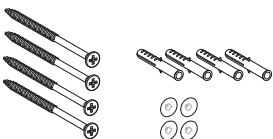
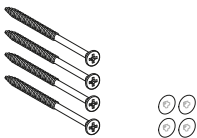

1

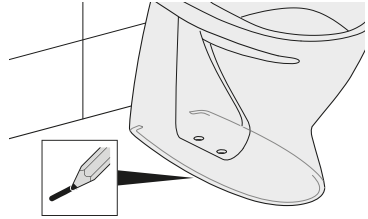

2

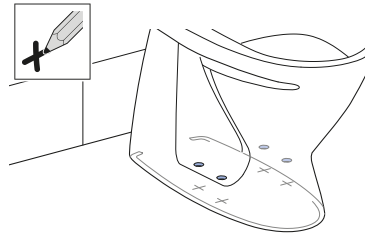

3

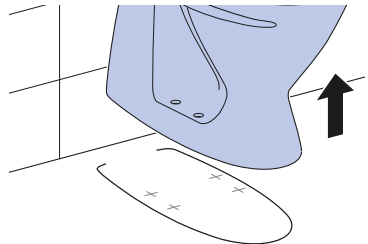

**i**

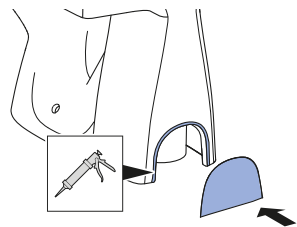

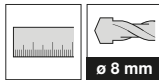

Seven D WC-10

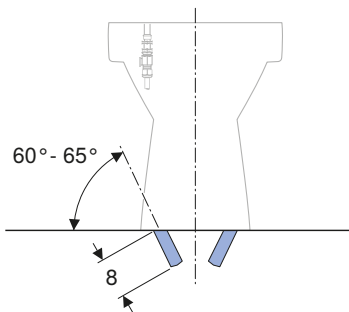

4



: SWE, FIN, DNK:  
EN 15651-3, Class XS1

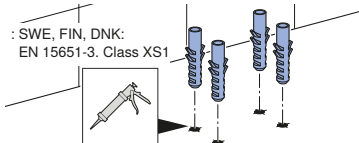

5

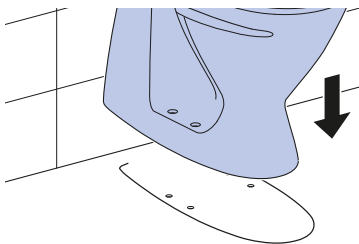

6

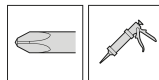

: SWE, FIN, DNK:  
EN 15651-3, Class XS1

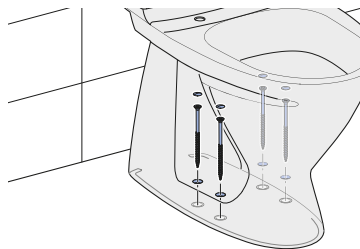

: SWE, FIN, DNK:  
EN 15651-3, Class XS1

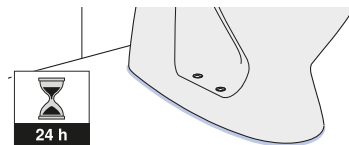

# B



1

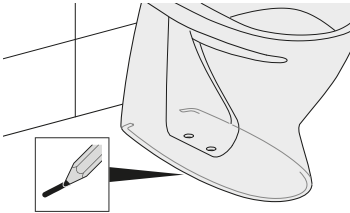

2

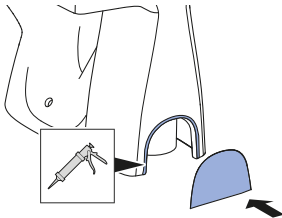
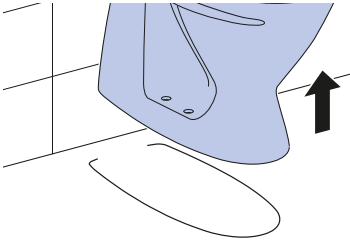

3

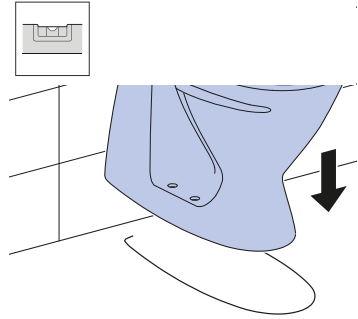

4

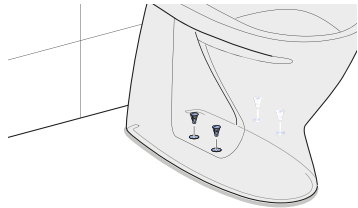

Geberit International AG  
Schachenstrasse 77, CH-8645 Jona  
documentation@geberit.com  
www.geberit.com

